



Select Gate 2M Software

© 2002 all rights reserved
Version 1.0.XXX Serial No. _____

For the Select Gate 2M Access System

**Select Gate 2M Series
Setup and Maintenance Software
for use in Windows 9X, ME, 2K & XP Operating
Systems**

**Select Engineered Systems, Inc.
7991 W. 26th Ave.
Hialeah, FL 33016**

Y2K Compliance Statement

Select Gate Software is designed to be used prior to, during, and after the calendar year 2000 A.D., and Select Gate Software will operate during each such time period without error relating to date data, specifically including any error relating to, or the product of, date data which represents or references different centuries or more than one century.

Select Gate Software will not abnormally end or provide invalid or incorrect results as a result of date data, specifically including date data which represents or references different centuries or more than one century;

Select Gate Software has been designed to ensure year 2000 compatibility, including, but not limited to, date data century recognition, calculations which accommodate same century and multi-century formulas and date values, and date data interface values that reflect the century;

This statement should not be taken to mean that Select Gate Software corrects any errors generated by your computer, it's BIOS (Basic In Out System), or your operating system or any other program you have or use.

Definitions

Four Digit Year Format

shall mean a format that allows entry or processing of a four digit year date: the first two digits will designate the century and the second two digits shall designate the year within the century. As an example, 1996 shall mean the 96th year of the 20th century.

Leap Year

shall mean the year during which an extra day is added in February (February 29th). Leap Year occurs in all years divisible by 400 or evenly divisible by 4 and not evenly divisible by 100. For example, 1996 is a Leap Year since it is divisible by 4 and not evenly divisible by 100. 2000 is a Leap Year since it is divisible by 400.

Year 2000 Compliant

shall mean that the data outside of the range 1990-1999 will be correctly processed by Select Gate Software including application programs, files and databases.

Select Engineered Systems, Inc. Life Support Policy

Select Engineered Systems, Inc. products are not intended for use in life critical situations or as critical components in life support devices or systems.

Life Support devices or systems are defined as devices which are intended for surgical implant into the body, or for support or sustaining life, and whose failure to perform, when used in accordance with the instructions provided by the manufacturer, might result in injury to the user.

Select Engineered Systems, Inc. reserves the right to make improvements in the hardware, firmware, and software described in this manual at anytime and without notice.

Notice To Windows 95 Users

Select Gate Software may not operate correctly, unless Windows 95 ver. 4.00.950a (Service Pack 1) or higher is installed !

Tip: If you don't know which version you're running, our manual (page 2) will walk you through finding out.

WARNING : If you are running any custom or non-compliant Windows software you should check with your software provider to insure adding this update will not effect your programs !

Instructions for updating Windows 95 with service Pack 1

1. Do not install unless your Version is 4.00.950 (no suffix)
2. Quit any applications that are currently running.
3. If you use Microsoft Plus! System Agent, right click the System Agent icon on the toolbar, and then click suspend System Agent.
4. Create a temporary folder on your hard drive.
5. Click the link "Windows 95 Service Update."
6. Save the file in the new folder.
7. In that folder, double click Setup.exe, then follow the instructions.

When the Setup.exe program finishes, your version of Windows 95 will be version 4.00.950a.

Notice To Windows NT 4.0 Users

Select Gate Software uses latest Microsoft Report Generator which is incompatible with Windows NT 4.0 network systems and workstations.

WARNING: Installing Select Gate Software into a Windows NT 4.0 system or workstation, WILL damage your system.

Select Gate Software

Table of Contents

System Requirements	Page 6
Select Gate Software Requirements	Page 6
Installation Instructions	Page 7
Startup and Operation	Page 8
Setting a Default Unit	Page 9
View Phones, PIN's and Cards	Page 10
Adding Phones, PIN's and Cards, Step by Step	Page 12
Entrance Relay Control	Page 14
Call Forwarding and Configuration	Page 16
Time Schedule and Holidays	Page 18
Send / Receive Data Configuration	Page 20
Multiple Unit Configuration and Send / Receive	Page 22
Add Select Gate Unit	Page 24
View Activity Log	Page 25
View / Print Reports	Page 26
Terminal	Page 27
Helpful Hints and Short Cuts	Page 28
Addendum's – Select Gate Hardware Instructions	Page 29
Index	Page 35

Select Gate Software System Requirements

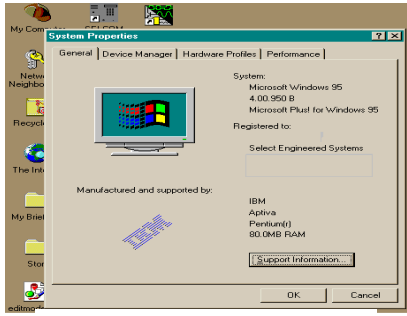

System Properties

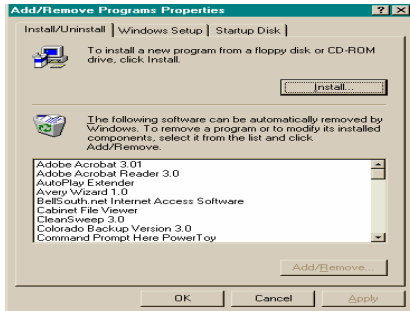

Add-Remove Programs

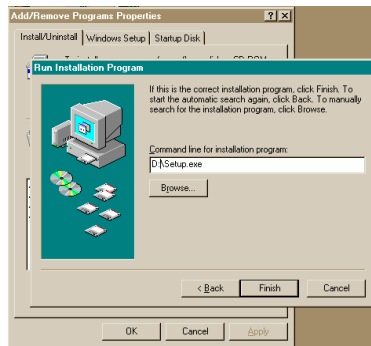

Select Program



First Screen

Operating System:
Windows 9X,ME Ver. 4.00.95a or higher
Windows 2K,XP Ver 5.0 (Service Pak 2) or higher

Hardware:

Computer Processor

Pentium Recommended

System RAM or Total Memory

64 Mb. Recommended

Available Physical Memory

20 Mb. Recommended

Note:

Available Space or Hard Disk Storage Required

50000 KB or 50 Mb. max plus 1 - 2 Mb. per site

Installation Drive

CD-ROM installation of Software

Note: 80486 is not recommended because of low performance, but may be used in limited applications

System Requirements to install this Software

This program requires up to 50.0 megabytes of hard disk and includes 12 megabytes of system files that may need to be installed. You therefore need a minimum 50 megabytes of space to install this program for one site. More sites require 1 to 2 Mb. per site, depending on site size and the amount of backups used. **During operation, Select Gate Software will require up to 20mb. of free ram to operate efficiently depending on the size and model of the unit . Note: 20Mb. is available in 32Mb. total memory ONLY when NO OTHER Programs are running. With less memory the program may operate, but with poor performance.** This program will only operate correctly in Windows 9X®

with Service Pack 1 installed or higher or in Windows 2K or Windows XP®. If you are unsure, select the "My Computer icon on your desktop and **RIGHT** click it. Once the panel is opened, select Properties and **LEFT** Click it. A "Systems Properties" screen will open and under System:, it must say:

Microsoft Windows 95

**4.00.950a (includes service pak 1) or
4.00.950B (does not need service pak 1) or higher
Windows 98**

Windows ME

Windows 2K (SP2) or higher, Windows XP®

If it does not, contact Microsoft or your local computer dealer for Service Paks and install this update in your computer prior to continuing. Service pak 1 is to be installed in Version 4.00.950 only. It is already in place in 4.00.950a. The 4.00.950B version does not require and may be damaged by installing this update. Installation instructions for this Service Pak are included on the disk or in the Service Pak directory of the CDROM. Windows NT® requires **separate** service paks.

Select Gate Software Installation Instructions

Setup will warn you to Shutdown any running programs. You **MUST** shutdown **“Microsoft Office”** as it will disrupt the installation.

If you are running the **“Office Toolbar”**, you **MUST** close the **Office Toolbar** and all it’s applications and you should close any other applications running to insure a proper installation.

Once you have checked that you have the proper Revision, place the CD ROM disk into your CD-ROM Drive.

Go to Start then select “Settings”, then “Control Panel”, then “Add-Remove Programs”.

Select “Install” **If your main files are out of date, setup will prompt you to restart your computer. After doing so, start setup again.**

Add -Remove will locate the disk and confirm it’s name (Select Gate Software) and location.

Select Gate Software setup has a standard location for it’s files, but will give you the chance to choose another location and name of the directory, then will install the program.

Select Gate Software uses a “Completion Gauge” to indicate the percentage of the installation completed.

If files in your computer are damaged, setup will inform you of the fact, and abort the installation.

At the end of the installation, Setup will indicate a complete and proper Installation.

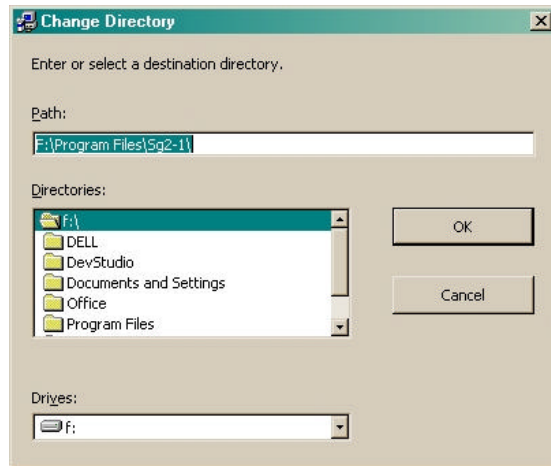

Choose Directory

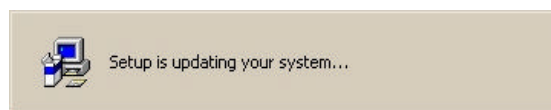

Installing.....



Complete.....

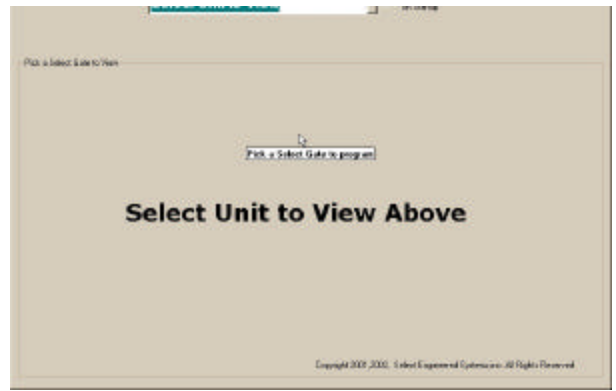

Startup and Operation

Select Gate Software is only for use with Select Gate 2 Units Main Screen at Startup with a modem or serial connection installed.

Startup

Select Gate Software places a menu selection in your Startup Directory. Select and the Main Screen will appear. Select Gate Software is shipped from the factory with a Sample Unit in the software for you to use as an example.

Help

Help is provided for each item. To use, place the mouse pointer over the item you need assistance with and a description or instructions will appear on the screen automatically. This feature is provided on all screens.

Main Menu

The Main Screen appears blank with several selections possible.

- ⇒ Select Unit to View [**Window**]
- ⇒ Show a Select Gate on Start up.

Select Gate Software is shipped with two example units to allow you to view and learn this program. You may wish to start with selecting one of these units and using it to explore the features of Select Gate Software . These instructions are written using “Sample Select Gate” as its example. If you wish to start by setting up your unit, go to the section of these instructions for the “Add Select Gate Unit (Wizard)”. Or continue by selecting “Sample Select Gate” in the top center selecting window. As you add your Unit(s) this selector will expand to show all units installed in the software in alphabetical order for your convenience. There is no limit to the number of Select Gates units allowed, except the physical capacity of your computer. Each unit installed uses about one to two megabytes of storage space depending on the size of the unit and the number of backups used. After the selection is made, “Command Buttons” will appear and the menu system will expand to include the software features.

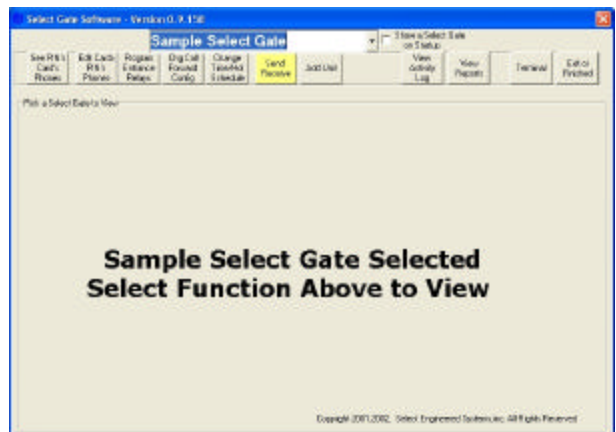

Screen w / Sample selected, showing Function Buttons available after Selection is made.

Show a Select Gate on Startup

Select Gate Software has the ability to return to the same unit, every time you start the program. You may turn on this feature by selecting "Show a Select Gate on Startup". The feature is especially handy if you only have one Select Gate or two Select Gates on a single line. This option is a two step process used after a unit is created. (See Page 24 to create a unit.)

1. At the top of the screen, check "Default Unit Selected"
2. Select this unit with the Select Unit to View Window and then select the "Send Receive Button". On the "Send Receive Screen, check the "Select to have this Select Gate to appear when program starts" check box.

After this, when the program is started, this unit will be automatically chosen and it's data will appear. However, any other unit may be chosen at any time.

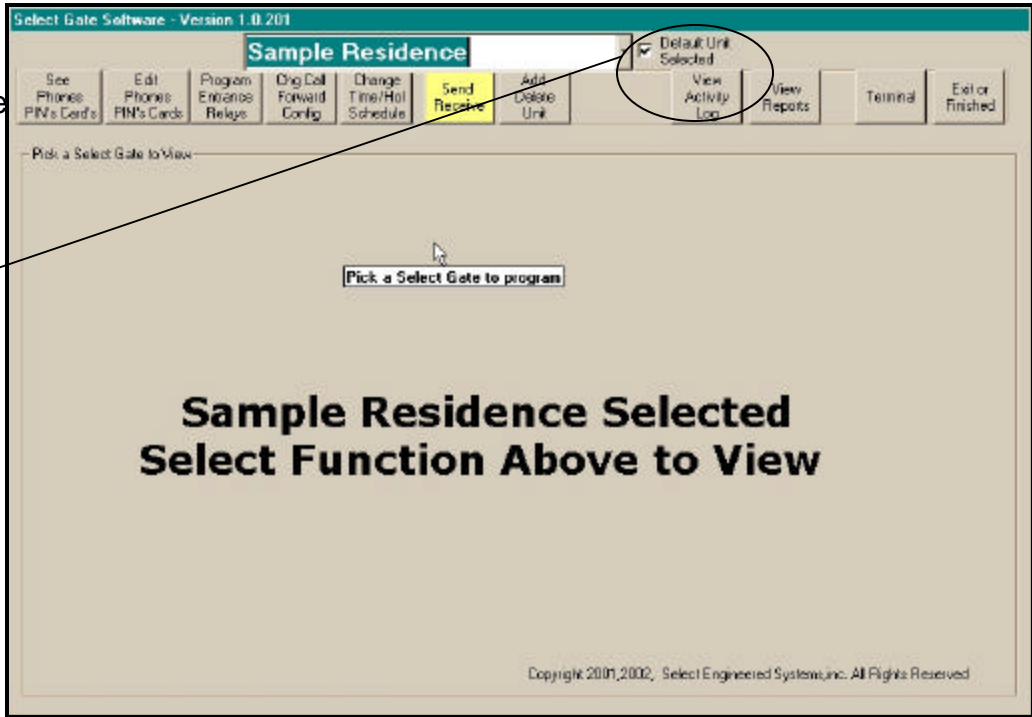

Start Page showing Default Site Checked (Activated)

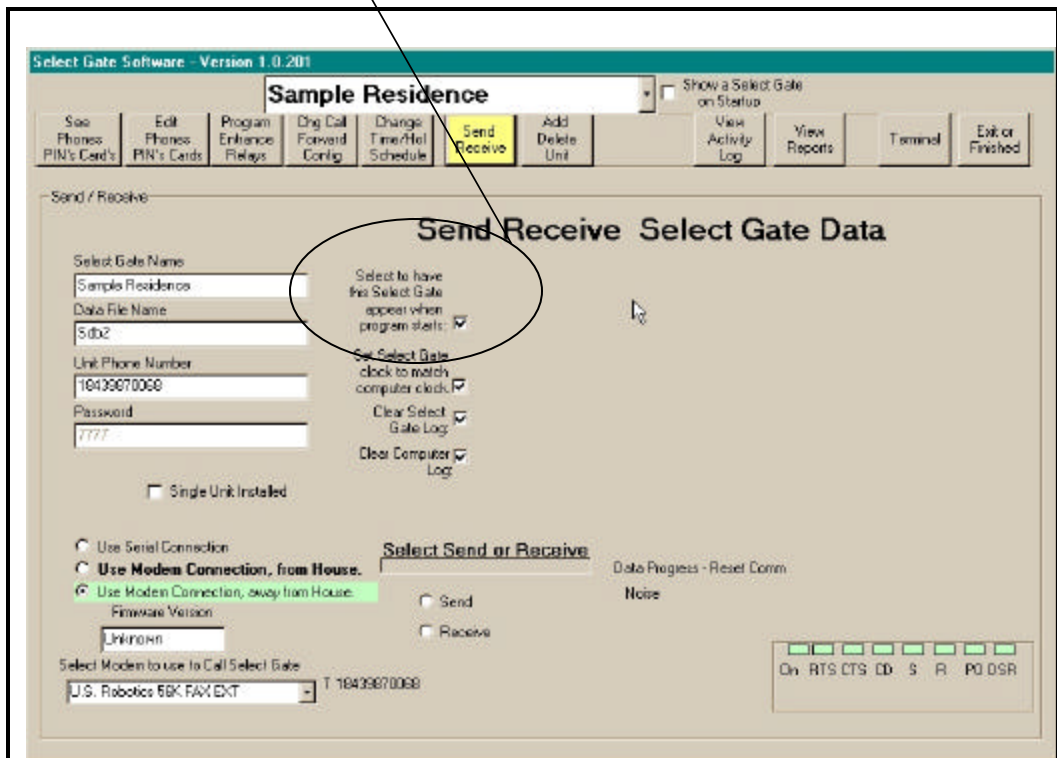

Send Receive Page showing Sample Select Gate selected as Default startup unit.

Viewing Phone Numbers, PIN Numbers and Access Device Numbers

Select Gate Software incorporates a new style Directory view and editing system. Note that the Unit Site name is featured at the top of the screen. This feature remains on each screen to assist the user. The view data display is in a Columns and Rows format showing ALL data in the unit. The opening display is always sorted in numerical location order by type of entry. The data is shown with Phone numbers (if any) shown first, then PIN numbers (if any), shown next and Access Devices Numbers (If any are labeled “Card Numbers“), shown last. The Elevator bars appear when needed and allow the user to move through the list of names and to view the additional data for each name. The user may use the selector buttons to select what type of data they may wish to view. Gauges are provided on the side of the screen to inform the user of the number of Phone Numbers, PIN numbers and card numbers issued into the Select Gate Software. This may be used to determine the percentage of the Unit capacity used. In Displays larger than 600 x 800, the user may enlarge the view by dragging the edges of the directory. The number of items used and the number remaining are also shown.

Select Gate Software - Version 1.0.201

Sample Residence

Show a Select Gate on Startup

All Data View

View Selection: View All View Phones View PIN's View Cards View Expired Items

DataType	Loc	Name	Data	Start Date	Stop Date	Action	Time Zone
Phone	01	MAIN HOUSE	(512) - 555 - 1112	N/A	N/A	N/A	0
Phone	02	MARY CELL	(512) - 555 - 1116	N/A	N/A	N/A	0
Phone	03	JENNY CELL	(512) - 555 - 1121	N/A	N/A	N/A	0
PIN	01	SUMMER HSEKPER	1234	05/12	09/15	Ent.1 Open w/Timez	1
PIN	02	POOL GUY	2580	01/01	10/31	Ent1 Open	0
PIN	25	TEST 25	4321	05/12	09/15	Ent.1 Open w/Timez	0
Card	01	CTB	010 - 00150	00/00	00/00	Ent1 Open	0
Card	02	MARY	010 - 00355	00/00	00/00	Ent1 Open	0
Card	03	GINNY	001 - 04580	00/00	00/00	Ent.1 Open w/Timez	9
Card	04	TOMMY	001 - 00450	00/00	00/00	Ent.1 Open w/Timez	9
Card	05	TEST TIMEZONE	001 - 12345	00/00	00/00	Ent.1 Open w/Timez	1

Phones Used - 3 of 10
PIN's Used - 3 of 100
Card's Used - 5 of 100

Add New Item

Unit Data Display Spreadsheet View

- ◆ **DATA Type:** This column indicates the type of data displayed in this row. The Data is separated into Phone numbers that may be dialed from the Select Gate, PIN numbers that may be used at the Select Gate or auxiliary keypad, and Card Numbers (Access Devices Numbers)
- ◆ **Loc:** This is the **Location Number** used by the Unit to store this item. If it is a Phone number, it is the number, plus the # key, that the User presses to dial the Number shown in the Data Display. If it is a PIN or Card Number, then the number indicates the “Storage location“ used in the software and the Select Gate to store the entry.

Unit Directory Control

Note:

In order for any data entered to be in your Select Gate, you must “Send Data” to the Select Gate to program it. Just entering items into the Select Gate Software does not program the Select Gate.

- ◆ **Name:** This is your reference name to identify the person or purpose of this entry. If the data was entered into the Select Gate directly, when you will see “New from Select Gate as the name, as the reference names cannot be stored in the Select Gate.
- ◆ **Data:** The “Data Field” contains the actual data sent to the Select Gate. This will be the actual phone number dialed, the actual PIN number used or the actual site code – card number used.
- ◆ **Start Date – Stop Date:** You may wish to give out ‘Temporary’ PIN’s or Cards. To make ANY PIN or Card temporary, assign a start month and day (the first day you wish the PIN or Card to be active) AND a stop month and day (the last day you wish the PIN or Card to be active). You must enter BOTH the month and day for BOTH start and stop or fields reset to 0 and the card becomes ACTIVE Permanent and will never expire, until removed.
- ◆ **Action:** Your Select Gate, depending on configuration, may control up to two entrances with several functions for each Entrance or Relay. See Action table.
- ◆ **Time Schedule:** You may wish to limit the usage of each PIN or Card to certain days of the week and/or hours of the day. The Select Gate has seven individual time zones and two combined time zones for you to select when individual PIN’s and Cards are active. (See page 18 for Time Schedule Setups)

Action Table	
0	Ent.1 Open
1	Ent.1 Open w/Timezone
2	Ent.2 Open w/Timezone
3	Ent.1&2 Open w/Timezone
4	Ent.1 Latch wTimezone
5	Ent.2 Latch w/Timezone
6	Ent.1&2 Latch w/Timezone
7	Ent.1 Open 1 Hr w/Timezone
8	Ent.2 Open 1 Hr w/Timezone
9	Ent.1&2 Open 1 Hr w/Timezone

Entering Phone Numbers, PIN Numbers and Access Device Numbers

Step by step Instructions to enter new items

Select Gate Software provides a simple screen to enter new data into the directory.

- 1) **On the Main Screen**, Select or “Click” the **PROPER UNIT** to enter the new items.
- 2) **On the Main Screen**, Select or “Click” the **“Edit Phones PIN’s Cards”** command button. The directory editor screen will appear.
- 3) **On the Editor screen**, Select or “Click” the **Add** command button. The screen will change to the **Add** view. All of the entries will be removed except the First item required. The title and instruction line will change to indicate the user action required.
- 4) **Start the entry by entering the type of entry**. You must know the type of entry (Phone, PIN, Card) you are entering into the software. Select it from the Pull-Down menu.
- 5) Select the **Location** in the Select Gate you wish to place the item.
- 6) **If the Location has been already used**, the screen automatically displays the record and changes to edit mode. You may change any and all items in this record, **except** the code number. When you send Data, all items in this record would be changed, **except** the code number.
- 7) **If the code has not been used**, the screen automatically steps or moves to the reference name field for entry. **Enter the name reference you wish to use for this entry**, this name is for your use to identify this item to you. You may use the [Tab] or [Enter] key to move through the windows and enter the information you require. **Only the location number and item data is necessary in any record**. All other fields are optional. When you send Data, this record will be added.
- 8) **Enter the data for this item**. Enter Phone numbers without dashes or parentheses. **(Example: Dialing a long distance call to area code 305 with a phone number of 555-1212 would be entered as “13055551212”**. Enter the PIN as a 4 digit number only. Enter a card as three digits for the facility code and 5 digits for the card number. **(Examples: Facility Code 135 with a card number of 12345 would be entered as “13512345”**. Facility Code 1 with a card number of 2 would be entered as **“0010002”**. **You must use the leading zeros.**) Do not enter dashes or parentheses. The system will add these automatically in the “See Phones PIN’s Cards” view.
- 9) **If the entry is a PIN or Card, Enter the Start and stop Dates for this entry**. If this is a Permanent card skip these entries.
- 10) **If the entry is a PIN or Card, Enter the ‘Action you wish this entry to perform**. Normal action is ‘0’ to open the primary entrance momentarily. See Action Table guide on Page 11 for other functions

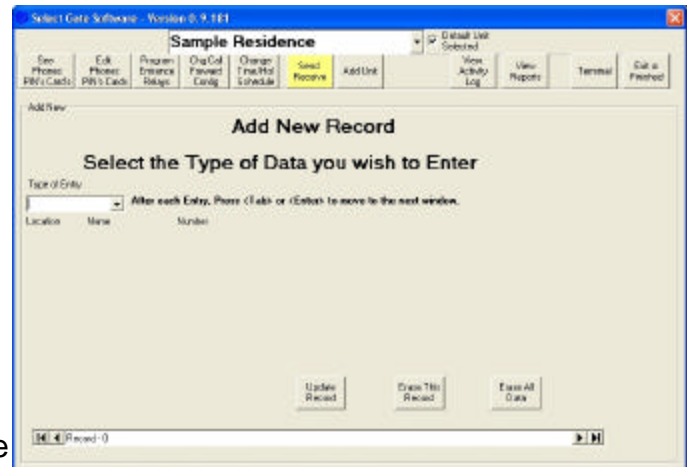

Data Limits	
Loc Number	10 Phones, 100 PIN numbers, 100 Cards
Name	14 Characters visible, up to 50 may be used
Phone	up to 14 Digits
PIN	4 Digits
Cards	3 digit Site Code and

Select Gate Software places both entrance configuration data on one screen. Complete descriptions of each item is available by placing the mouse pointer over each item. The example data is provided as a reference. Each function may be named and the controlling functions may be programmed.

Select Gate Software - Version 1.0.201

Sample Residence Show a Select Gate on Startup

See Phones PIN's Card's | Edit Phones PIN's Cards | **Program Entrance Relays** | Chg Call Forward Config | Change Time/Hol Schedule | Send Receive | Add Delete Unit | View Activity Log | View Reports | Terminal | Exit or Finished

Control Relay Configuration

Entrance Relays

Relay 1 Name: Main Gate Relay 1 Open Time: 02 Relay 1 Open Tone: 1

Relay 1 Open 1 Hour Tone: 3 Relay 1 Latch Open Tone: 2 Relay 1 Auto Unlock Time Sched: 1

0 2 4 6 8 10 12 14 16 18 20 22 24 Su Mo Tu We Th Fr Sa Su
7.45.....17.00 [Green] [Green] [Green] [Green] [Green] [Green] [White]
00.00.....00.00 [White] [White] [White] [White] [White] [White] [White]

Relay 2 Name: Horse Barn Relay 2 Open Time: 02 Relay 2 Open Tone: 4

Special Function: 0 Relay 2 Open 1 Hour Tone: 6 Relay 2 Latch Open Tone: 5 Relay 2 Auto Unlock Time Sched: 1

0 2 4 6 8 10 12 14 16 18 20 22 24 Su Mo Tu We Th Fr Sa Su
7.45.....17.00 [Green] [Green] [Green] [Green] [Green] [Green] [White]
00.00.....00.00 [White] [White] [White] [White] [White] [White] [White]

- ◆ **Relay 1 & 2 Name:** This is your name for this control. Relay 1 is normally used to operate your Main Entrance and is named for it. (Examples; Main Gate, Front Gate, Automobile Gate, etc.. The range is 1 to approximately 21 visible characters.
- ◆ **Relay 1 & 2 Open Time:** This function is the amount of time the relay contacts remain closed when commanded. The amount of time required will depend upon the actual construction of the gate. Consult with your Gate Installer for the optimum settings. The range of time is 1 to 99 seconds. This tone will also unlatch or close a open entrance or gate.
- ◆ **Relay 1 & 2 Open Tone:** This function is the number you would press on your touch tone phone to open this entrance when someone calls you from the Select Gate or when you call the Select Gate in programming mode (See Page 3 of User Guide). The range is 1 to 9 and 0 = Off
- ◆ **Relay 1 & 2 Open 1 Hour Tone:** This function is the number you would press on your touch tone phone to open this entrance for 1 hour when someone calls you from the Select Gate or when you call the Select Gate in programming mode (See Page X). The range is 1 to 9 and 0 = Off
- ◆ **Relay 1 & 2 Latch Open Tone:** This function is the number you would press on your touch tone phone to Latch and Hold open this entrance when someone calls you from the Select Gate or when you call the Select Gate in programming mode (See Page X). The range is 1 to 9 and 0 = Off. Note: Remember to unlatch an entrance or gate, use the open tone.
- ◆ **Relay 1 & 2 Auto Unlock Time Schedule:** This function is the Time Schedule number you select to have the entrance remain open during the selected days / hours. (See Time Holiday Schedule Page 18). The range is 1 to 9 and 0 = Off. When a Time Schedule is selected, It's settings are displayed on this screen. To display another, change the selection and the chosen one will be displayed. However you must go to the 'Change Time/Holiday Schedule' to change each Time Schedule Settings.
- ◆ **Relay 2 Special Function:** This function sets the relay to turn on during a call to the house. 0 = Off 1 = On. Other relay functions are still active.

Entrance Configuration Table		
Item	Range	Default
Relay 1- 2 Name	Approx 20 characters Showing – 50 Characters	Relay 1(2)
Relay 1- 2 Open Time	1 to 99 sec's	2 sec's
Relay 1- 2 Open Tone	0 to 9, 0 is off	6 on Rly 1 0 on Rly 2
Relay 1- 2 Open 1 HourTone	0 to 9, 0 is off	0
Relay 1- 2 Latch Open Tone	0 to 9, 0 is off	0
Relay 1- 2 Unlock Time Zone Schedule	0 to 9, 0 is off	0

Change Call Forwarding & Configuration Setup is a group of user configurable items. This group includes Call Forwarding, Call House Blocking (Do not Disturb), Select Gate ring Selections, Unit Password, PIN Control and other misc. items. A description of each item may be viewed by placing your mouse pointer over each item of interest.

Select Gate Software - Version 1.0.201

Sample Residence Show a Select Gate on Startup

See Phones PIN's Card's | Edit Phones PIN's Cards | Program Entrance Relays | **Chg Call Forward Config** | Change Time/Hol Schedule | Send Receive | Add Delete Unit | View Activity Log | View Reports | Terminal | Exit or Finished

Calling Configuration

Select Gate Configuration Setup

<h4>Call Forwarding Setup</h4> <p><input type="checkbox"/> Call Forwarding On:</p> <p><input checked="" type="checkbox"/> Call Forwarding Reminder Ring On:</p> <p><input type="checkbox"/> Call Forwarding Activation Tone:</p> <p>Call Forward Phone Number: 5125551212</p> <p>Call Forward (Enable Calling) Schedule: 1</p> <p>0 2 4 6 8 10 12 14 16 18 20 22 24 Su Mo Tu We Th Fr Sa Su 7.45.....17.00</p>	<h4>Distinctive Ringing Setup</h4> <p>Select Gate Ring Cadence: Short Long 2</p> <p>Call Waiting Tone Cadence: Short Short 1</p>
<h4>Call House (Do not Disturb) Setup</h4> <p>Call House (Enable Calling) Schedule: 8</p> <p>0 2 4 6 8 10 12 14 16 18 20 22 24 Su Mo Tu We Th Fr Sa Su 21.45.....23.59 0.00.....7.15</p>	<h4>Misc. Items Configuration</h4> <p>Call Talk Time: 1 <input checked="" type="checkbox"/> Back Beep During Call</p> <p>Set House Ring count before stops: 9 <input checked="" type="checkbox"/> Keypad On:</p> <p>Programming Password: 7777 PIN Strike out Count: 3</p> <p>Ring in Count: 09 PIN Lockout Time: 1</p>

Change Call Forward and Configuration Screen

Call Forwarding Setup

- ◆ **Call Forwarding On:** Call forwarding causes the Select Gate to call the number. Check this item and send data to the Select Gate(s) to turn call forwarding on. When this item is unchecked, call forwarding is turned off and pressing the Call Button will call the house. When call forwarding is on, pressing the Call Button will cause the Select Gate to call the phone number entered and send a short reminder ring to the house, if chosen.
- ◆ **Call Forward Reminder Ring On:** This option will cause a "Reminder Ring " to be sent to the house, to inform you that call forwarding is on.
- ◆ **Call Forwarding Activation Tone:** Call Forwarding may be turned On / Off from any phone connected to the same line as the Select Gate. This is the touch tone button to press to turn Call Forwarding On / Off.
- ◆ **Call Forward Phone Number:** This is the phone number that will be dialed when Call Forwarding is on and the Call Button is pressed.

- ◆ **Call Forward (Auto Enable Calling) Schedule Time Schedule:** Call Forwarding may be controlled with a Time Schedule to automatically restrict Call Forwarding to certain Days of the week and Time(s) of the day. For example, you might set a Time Schedule to include 9:00AM to 5:00PM, to prevent calls to the house during your working hours and send them to your place of business or cell phone. You may allow access to your residence from the call forward number, if the called phone allows sending touch tones after answer. The active hours and days of the Time Schedule are the “Active” ringing hours of the Select Gate. When a Time Schedule is selected, It’s settings are displayed on this screen. To display another, change the selection and the chosen one will be displayed. However you must go to the ‘Change Time/Hol Schedule’ to change each Time Schedule Settings.
- ◆ **Call House (Do not Disturb) Setup:** Call the House may be controlled with a Time Schedule to automatically restrict House calls to certain Days of the week and Time(s) of the day. For example, you might set a Time Schedule to include 7:00AM to 11:00PM, and not include 11:01PM to 6:59 AM to prevent calls to the house during your sleeping hours. The active hours and days of the Time Schedule are the “Active” ringing hours of the Select Gate. When a Time Schedule is selected, It’s settings are displayed on this screen. To display another, change the selection and the chosen one will be displayed. However you must go to the ‘Change Time/Hol Schedule’ to change each Time Schedule Settings.
- ◆ **Select Gate Ring Cadence:** You have 4 ring cadence selections to choose to identify the call is coming from the Select Gate. (Short – Short, Short – Long, Long – Short, Long – Long.)
- ◆ **Select Gate Call Waiting Tone Cadence:** You have 4 tone cadence selections to choose from to identify the “Call Waiting “ tones are coming from the Select Gate. (Short – Short, Short – Long, Long – Short, Long – Long.)
- ◆ **Call Talk Time:** You may limit the call time during Select Gate Call Forwarding or Number calling. After the set time, the Select Gate will automatically disconnect the call. Settings are from 1 to 99 Min. A house call is not time limited and is terminated by hanging up the house phone.
- ◆ **Set House Ring Count:** You may limit the number of rings the Select Gate sends to the house before it automatically stops. Range is 1 to 9 ring cycles.
- ◆ **Programming Password:** The programming password is the 4 digit number used to switch the Select Gate from Normal Mode to Programming Mode. The range is 000 to 9999. The factory default is 7777. The first two digits are used to send commands to the Select Gate. (See Page 16).
- ◆ **Ring in Count:** This option is used to program or command the Select Gate remotely. This is the number of rings coming into the Select Gate before it answers. If this option is set to zero, the Select Gate will never answer. Range is 1 to 99 ring cycles
- ◆ **Back Beep:** This option makes the Select Gate send ‘beeps’ during the conversation to inform you the call is from the Select Gate.
- ◆ **Keypad On:** This option allows the keypad to be used / not used during a call. This could be used to activate message machines for example.
- ◆ **PIN Code Strike Out Count:** If you elect to use PIN codes to operate the Entrance, this setting is for the number of INCORRECT PIN’s entry’s allowed before the Select Gate stops accepting key presses. 0 = Unlimited tries, however, this severely limits your security and should not be used.
- ◆ **PIN Lockout Time:** This controls the amount of time the Select Gate stops or locks out, before it begins accepting key presses again. Range is 1 to 9 minutes.

Time Schedule and Holiday Schedule

The Select Gate Holiday Schedule provides an easy way to setup your access configuration to your needs. Up to 10 holidays may be entered for special treatment. The date are entered as a 4 digit number as MONTHMONTHDayDay, as 0101 is January first and 0704 is July Fourth.

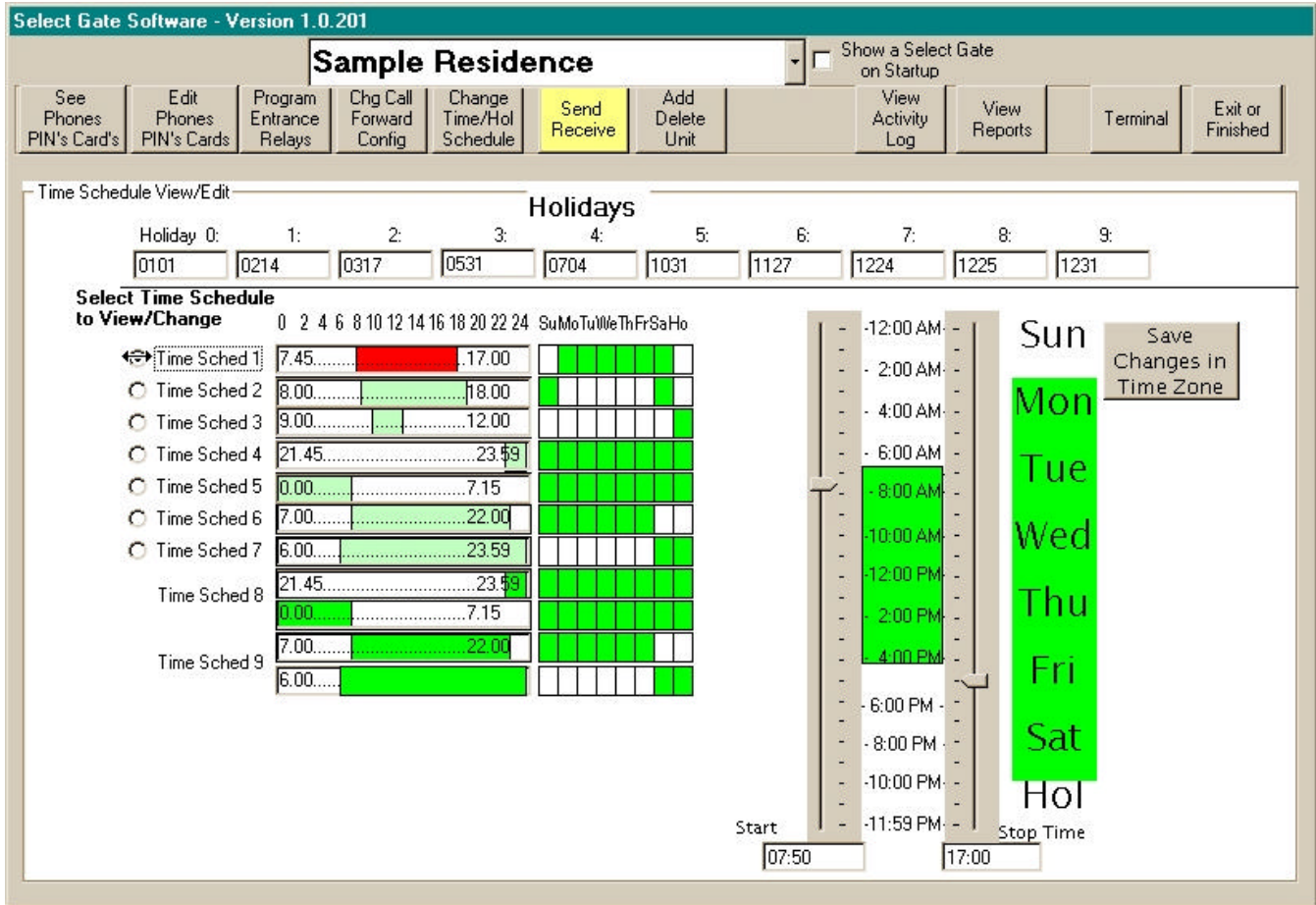

The Select Gate Time Schedule control provides a simple way to set up your timed access configuration to your needs. Timed Schedules can be used to automatically open your Gate or unlock your entrance during normal employee work hours. Other uses include limiting the calling hours to the house, automatically shifting the call to your work or mobile phone and limiting the use of individual access PIN's and Card type controlling devices.

Time Schedule 8 provides for the use of Time Schedule 4 and Time Schedule 5 COMBINED. Time Schedule 9 provides for the use of Time Schedule 6 and Time Schedule 7 COMBINED. This enables you to build a more complex schedule, if required. To use the controls you would do the following steps:

1. Select the Time Schedule you wish to change (Example shows Schedule 1 selected).
2. Move the Start Time and Stop Time Selectors to the desired times you wish this schedule to be ACTIVE. You may move either one first and the other as many movements as you wish. The time is selected in 15 minutes steps and is shown in the Start and Stop Windows below (Example shows 7:45 AM to 17:00 or 5:00 PM).
3. Select the days of the week by clicking each day desired in this schedule to be ACTIVE. (Example shows Monday through Saturday ACTIVE, Sundays and Holidays INACTIVE)
4. Click on 'Save Changes in this Time Zone' to complete the schedule change.

The following Select Gate features that can use Time Schedule functions are as follows:

1. **Control relays 1 and 2**. (Normally used for gate and entrance control)
2. **Calling the House** with the Call Button.
3. **Call forwarding**. Call forwarding changes the Call Button from calling the house to calling an outside number.
4. **PIN** access limiting
5. Limiting **Access Number Devices** which include cards, RF transmitters and proximity devices.

Note: When selecting time schedules for these features, a copy of the time schedule is shown at the feature page. **The time schedule may not be changed on the feature page.**

Send / Receive Data to Select Gate

Select Gate Software provides a choice selection screen to choose to SEND or RECEIVE information. During transmission the screen reports connection Progress, error correction, record numbers, elapsed time and other information. The system re-configures its settings to match the unit from a simple one unit application to a four unit Company Installation.

The ID of the unit is checked to insure the proper unit answered.

Choosing 'Send' will send the Select Gate configuration and ALL of the device data to the unit, then automatically disconnect, providing for the shortest connection time. The Select Gate Software allows you to delete items and devices and they will be deleted during the transmission. Do not change passwords while using the Select Gate Software as the password will not match connecting to the unit.

The Multiple Unit Function area allows the operator to call more than one unit when required and will only appear if MUI functions are selected during setup. See Page 22 for more detail.

Caution:

When 'Send' is used, the device items in the unit are replaced. Any codes in Unit and not in Select Gate Software are removed. Any codes altered are changed and new codes are added.

Call Configuration Settings - Single Unit

1. **Select Gate Name:** This is the name you choose to identify this Select Gate. This only becomes important when you are programming more than one Select Gate installation.
2. **Data File Name:** This is the name of the data file used by the Select Gate Software to store the configuration and device information for this Select Gate. This file name is used to share data files with units on separate phone lines.
3. **Unit Phone Number:** This field is used when the Select Gate to be programmed is on a separate phone line than the computer. Only one Select Gate may be accessed as the Select Gate answers by ring count.
4. **Password:** This is a four digit numerical password used to access the Select Gate. When you access the Select Gate from the house, the Select Gate(s) listen to the numbers dialed and if they match the password, the appropriate Select Gate will change to command mode. If you have more than one unit on a phone line, each unit MUST have a different password.
5. **Single Unit Installed / Multiple Units Installed:** This selector configures the Select Gate Software to call the proper type of installation. You must set this selector to the proper installation type or the software will operate erratically.
6. **Use Serial Connection:** Select this type of connection when you are connecting to the Select Gate with a serial connection. Be sure to select the proper Comm Port on your Computer when using this option.
7. **Use Modem Connection, from House:** This is the normal type connection for the Select Gate. It is used when the Computer you are programming with and the Select Gate are connected to the same phone line and number.
8. **Use Modem Connection, away from House:** This type of connection is used to connect to a Select Gate connected to another phone line. Only one Select Gate may be accessed as the Select Gate answers by ring count.
9. **Firmware Version:** This field is updated when you GET data from the Select Gate. It indicates the firmware version of the Select Gate and is useful, if you need to talk to Technical Support.

Select Gate Software - Version 1.0.201

Sample Company Show a Select Gate on Startup

See Phones PIN's Card's | Edit Phones PIN's Cards | Program Entrance Relays | Chg Call Forward Config | Change Time/Hol Schedule | **Send Receive** | Add Delete Unit | View Activity Log | View Reports | Terminal | Exit or Finished

Send / Receive

Send Receive Select Gate Data

Select Gate Name:

Data File Name:

Password:

Single Unit - Multiple Units Not Installed

Use Serial Connection
 Use Modem Connection, from House.
 Use Modem Connection, away from House.

Firmware Version:

Select Modem to use to Call Select Gate: T 5551234

Select Send or Receive

Send Receive

Data Progress - Reset Comm
Noise

On RTS CTS CD S R PD DSR

10. **Select Modem used to call Select Gate:** This selection configures the software to use THIS modem to place the call. You may have more than one modem in your computer and use separate modems to call different Select Gates.
11. **Select to have this Select Gate appear when program starts:** Checking this box to have THIS unit appear when the program starts without making a selection. This selection enables the Select Gate Software to pre-select this Select Gate automatically when the program starts. It is useful when you only have one unit or when you are working on a particular Select Gate. **Caution:** If more than one unit is selected the software will access the first available checked Select Gate.
12. **Set Select Gate clock to match computer clock:** Recommended. Checking this box will allow the Select Gate Software to set the clock to match the Day date and time to match your computer clock automatically. **Caution:** When using this feature, you should insure your computer has the correct Time and Date.
13. **Clear Select Gate Log:** Recommended. Checking this box to have the Select Gate log buffer cleared after the Select Gate Software receives the data. This will insure fresh data to load each time you obtain the data.
14. **Clear Computer Log:** Recommended. Check this box to have the Select Gate Software erase the old Data in the Viewing log PRIOR to loading the NEW data from the Select Gate. This will insure fresh data to view each time you obtain the data.
15. **Send or Receive (Single Unit):** Select Send or Receive to start your data transmission. When communication starts, a progress window will appear and show the step progress in the communication. In normal circumstances, no intervention is required. If a communication failure occurs, the progress window indicate where the communication failed.

Call Configuration Settings - Multiple Unit

Multiple Unit Calling with Different Data, Same Phone Line

Select Gate Software provides the capability to connect up to four Select Gate units on one phone line or many phone lines and send different data to each of the Select Gates. To use in this manner, use the 'Add Unit' to create a separate unit for each of the different groups of data. **Each Unit must have a different Password.** Use the above single unit method to communicate with each unit.

Select Gate Software - Version 1.0.201

Sample Company Show a Select Gate on Startup

Send / Receive

Send Receive Select Gate Data

Select Gate Name:

Data File Name:

Password:

Multiple Units Installed

Use Serial Connection
 Use Modem Connection, from House.
 Use Modem Connection, away from House.

Firmware Version:

Select Modem to use to Call Select Gate: T 5551234

Select to have this Select Gate appear when program starts:
 Set Select Gate clock to match computer clock:
 Clear Select Gate Log:
 Clear Computer Log:

Select
 Send
 Receive Data
 Receive Log

No. of Select Gate units on Phone Line:

Unit Name	Password to use
First MUI Unit to call: <input type="text" value="Main Gate"/>	<input type="text" value="6666"/>
Second MUI Unit to call: <input type="text" value="Truck Unit"/>	<input type="text" value="7777"/>
Third MUI Unit to call: <input type="text" value="West Gate"/>	<input type="text" value="8888"/>
Fourth MUI Unit to call: <input type="text" value="West Truck"/>	<input type="text" value="9999"/>

Data Progress - Reset Comm
Noise

On RTS CTS CD S R PD DSR

Multiple Unit Calling with SAME Data, Same Phone Line

Select Gate Software provides the capability to connect up to four Select Gate units on one phone line and send the SAME data to EACH of the Select Gate units in the Chain. In order to use this method the following conditions. The computer MUST be on the SAME phone line as the Select Gates. The Data for these units MUST BE the SAME. To activate this method, proceed with the following:

1. Click Select the 'Single Unit' check box until it indicates 'Multiple Units Installed.
2. You must select "Use Modem Connection from House'.
3. Type into the 'No. of Select Gates on Phone Line' the correct Number of Units connected.
4. In the windows provided, type in your name for each of the units connected and their password. Note: Each password must be different. If you provide the wrong password, either the wrong unit will answer, or NO unit will answer.
5. Once the system is configured, the data is stored in the software and will not have to be re-entered.

6. To use, consult the following:
 - a. Select the Send Receive Screen
 - b. Select the type of communication desired, ie.. Send, Receive, Receive Log.
 - c. The Communication Button will appear, titled with the desired type.
 - d. Click on the Communication Button to start the Call.

Multiple Unit Calling with SAME Data, Different Phone Line

Select Gate Software provides the capability to connect many Select Gate units on many phone lines and send the SAME data to EACH of the Select Gate units in the Chain. In order to use this method the following conditions. The Data for these units MUST BE the SAME.

To activate this method, proceed with the following:

1. Create the number of Units needed for the SAME Data. Use a preceding number or letter indicator in the Select Gate Name, to indicate a string of units, for your convenience. ie.. 'A North Fork, B North Fork, C North Fork, etc.
2. Note the **Data File Name** on any unit. (First Unit of chain recommended) This is the name of the data file used by the Select Gate Software to store the configuration and device information for this Select Gate. This file name is used to share data files with units on separate phone lines.
3. Select each unit in turn, and type in the EXACT SAME Data file Name in each unit.
4. Click Select the 'Single Unit' check box until it indicates 'Single Units Installed in each unit.
5. You may select "Use Modem Connection away House' in each unit, according to the installation and modems used.
6. Note: Each password must be the same. If you provide the wrong password, NO unit will answer.
7. Utilize the Single unit method to call each unit in turn, to load your data.
8. Data may be entered on any unit, and is the same for all units.

Add Remove Unit

The Add Remove selection now includes the ability to remove the “Selected Unit”. To use, select the Select Gate you wish to remove, Click the “Add Delete Unit” Button and Click the “Delete this Select Gate” Button. Answer “Yes” to the “Are You sure?” question and the Select Gate is Removed. If this is your Default Unit, **De-select “Default Unit” in the “Send Receive” screen and DeSelect Default Unit Selected at the top of any screen.**

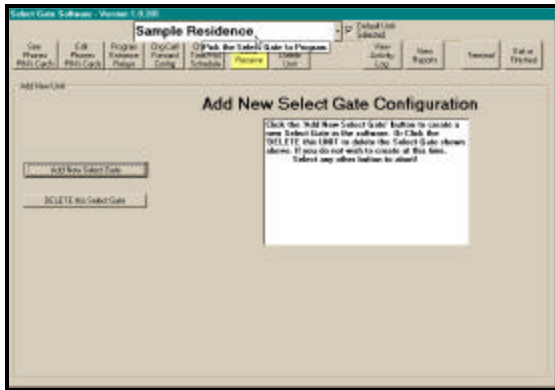

Add Unit

- ◆ Select Gate Software provides a ‘Wizard’ to help with the installation of a new Unit. It provides a step by step method of providing the information required and desired. You will need the following information at hand to ‘setup’ a new unit in the software Your Name for the Unit.
 - ◆ Unit Phone Number (optional if on separate line).
 - ◆ Unit Password.
 - ◆ Modem connection to be used.
 - ◆ Multiple Unit configuration if used.
 - ◆ Access Device codes and site code if used.
 - ◆ PIN numbers if used.
 - ◆ You must have a modem installed into your Windows System if you will be using that to communicate to the Unit. If a modem is properly installed, you will be able to merely **SELECT** it in a pull down selector box. If not, after you install a modem, you may select it later using the ‘Send Receive’ selection from the menu selectors.

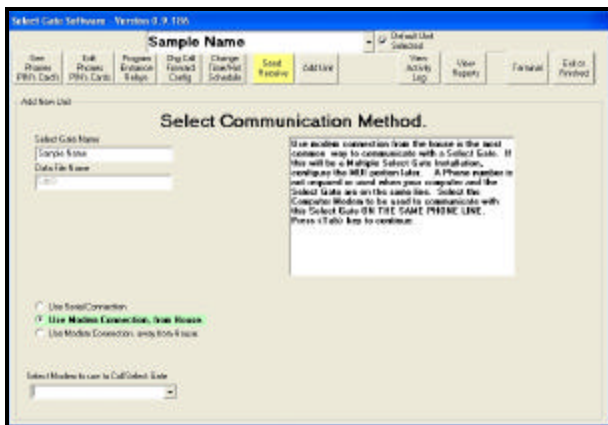
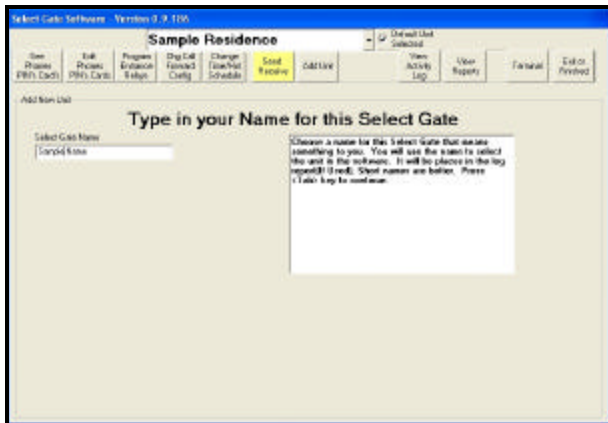

Using the Wizard

The Wizard takes you step by step through the information required, providing default answers when applicable. You may edit to correct any item without reentering the remaining data you previously entered after completion on the ‘Send Receive’ Selection.

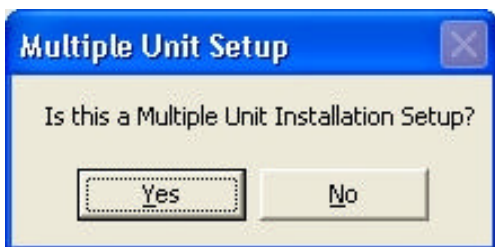

View Activity Log

Select Gate places Log data on one screen. The log viewer is capable of showing approximately 35,000 records. If more than this are retained in the file, they may be reviewed in the report screens. The default settings of erase the Select Gate Log after receipt and erase the Select Gate Software Log prior to getting a new log is recommended. The fields listed on the screen have the following:

- ◆ **Unit** - contains the file name you entered for the unit or the MUI name for this branch.
- ◆ **Loc** - contains the Unit's location for this item
- ◆ **Name** - the stored name for your reference.
- ◆ **Type** - The Type of Message reference.
- ◆ **Card or PIN Number** - contains the Card or PIN number used if applicable.
- ◆ **Action Code.** - the Actual Action Code sent from the Select Gate.
- ◆ **Action** - The action description based on the code from the Select Gate.
- ◆ **Date** - The date sent from the select Gate as Month Month date date – hours hours minutes minutes in military time. The actual year is not included.

Select Gate Software - Version 1.0.201

Sample Residence

Show a Select Gate on Startup

See Phones
PIN's Card's

Edit Phones
PIN's Cards

Program Entrance
Relays

Chg Call Forward
Config

Change Time/Hol
Schedule

Send Receive

Add Delete
Unit

View Activity Log

View Reports

Terminal

Exit or Finished

Log Viewer

Unit	Loc	Name	Type	Card or PIN No	Action Code	Action	Date
Test3 Select Gate	00		Msg		14	Caller hung up	01/18 - 16:46
Test3 Select Gate	00					House called by Unit	01/18 - 16:46
Test3 Select Gate	00		Msg		14	Caller hung up	01/18 - 16:46
Test3 Select Gate	00		Msg	01234	16	Invalid PIN xxxx attempted	01/18 - 16:46
Test3 Select Gate	00		Msg	01234	16	Invalid PIN xxxx attempted	01/18 - 16:46
Test3 Select Gate	00		Msg		38	Power on	01/18 - 16:54
Test3 Select Gate	00		Msg		11	House called by Unit	01/18 - 16:54
Test3 Select Gate	00		Msg		14	Caller hung up	01/18 - 16:54
Test3 Select Gate	00		Msg		00	Program Mode entered by seri	01/18 - 16:54
Test3 Select Gate	00		Msg		10	Exit Program Mode	01/18 - 16:54
Test3 Select Gate	01	Bobs PIN	PIN	01234	15	PIN code xx PIN xxxx used	01/18 - 16:59
Test3 Select Gate	00		Msg		22	Open relay 1 Timed	01/18 - 16:59
Test3 Select Gate	00		Msg		27	Close relay 1	01/18 - 16:59
Test3 Select Gate	00		Msg		38	Power on	01/21 - 16:17
Test3 Select Gate	01	Bobs PIN	PIN	01234	15	PIN code xx PIN xxxx used	01/21 - 16:18
Test3 Select Gate	00		Msg		22	Open relay 1 Timed	01/21 - 16:18
Test3 Select Gate	00		Msg		27	Close relay 1	01/21 - 16:18
Test3 Select Gate	00		Msg		11	House called by Unit	01/22 - 13:40
Test3 Select Gate	00		Msg		14	Caller hung up	01/22 - 13:40
Test3 Select Gate	00		Msg	01111	16	Invalid PIN xxxx attempted	01/22 - 13:41
Test3 Select Gate	00		Msg		10	Exit Program Mode	01/30 - 11:50
Test3 Select Gate	00		Msg		00	Program Mode entered by seri	01/30 - 14:05

- ◆ This screen is for Selecting a report to View / Print. The available reports are displayed as command selection buttons
- ◆ **View / Print Configuration** - This report views and prints all configuration items including Time Schedules
- ◆ **View / Print Phones, PIN's and Cards** - This report views and prints some or all Phones, PIN's and Cards in the software.
- ◆ **View / Print Activity Buffer.** This report views and prints some or all of the Log Activity in the Software.
- ◆ **View / Print** This report views and prints some or all of the removed expired PIN and Card Data.

Select the report you desire to view and it will appear. Buttons at the top allow for printing and export of the Report Data..

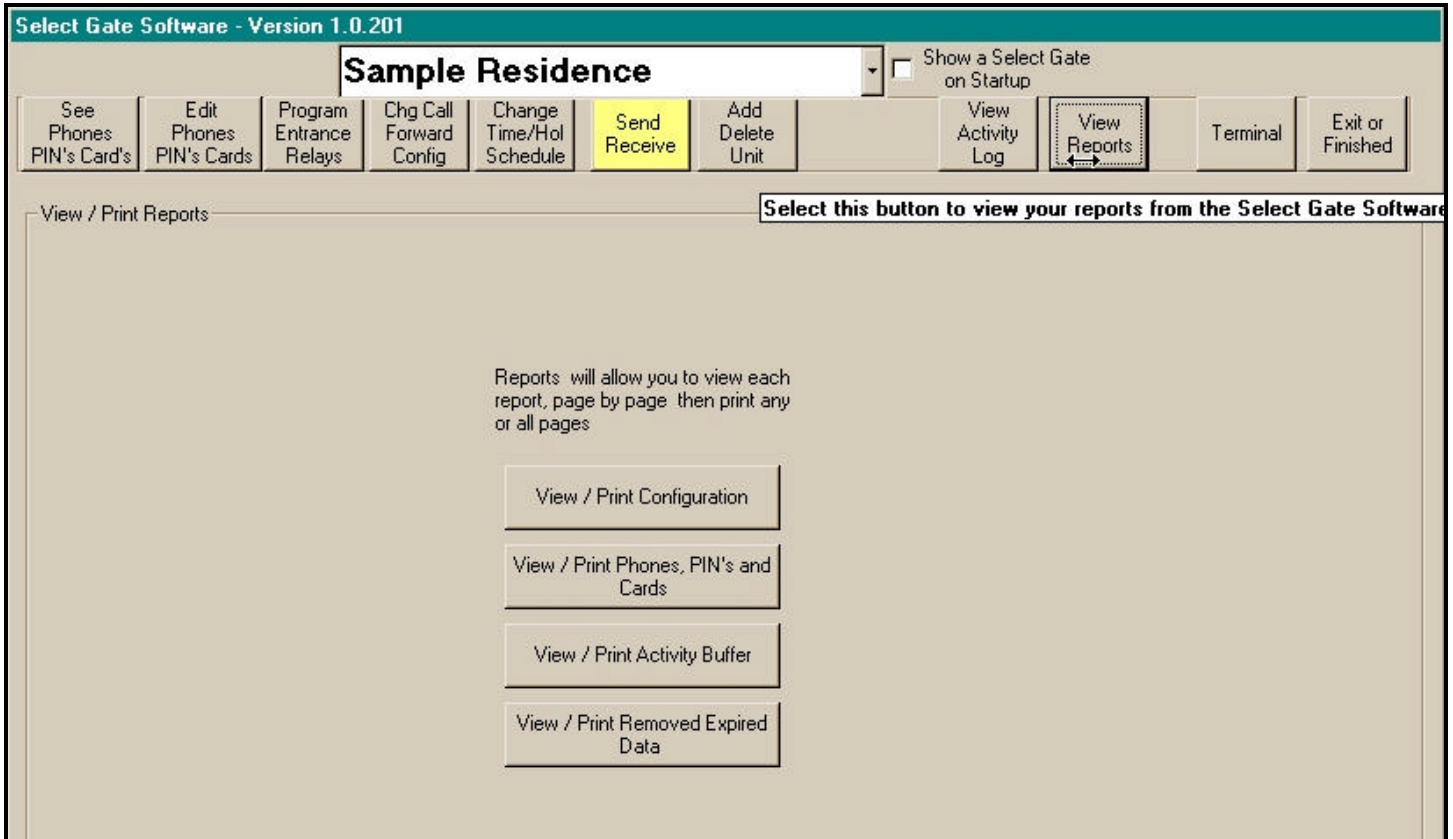

Terminal

Terminal provides you a way to setup various features and functions in your Select Gate directly. Care should be taken in changing settings using the terminal, as the Select Gate Software will not reflect these changes unless you do a GET Data to this unit.

However, changing the password and verifying the data contained in the Select Gate is accomplished the fastest using the terminal.

The data in the Select Gate is accessible through a menu system containing the same items and verbiage as the Select gate software.

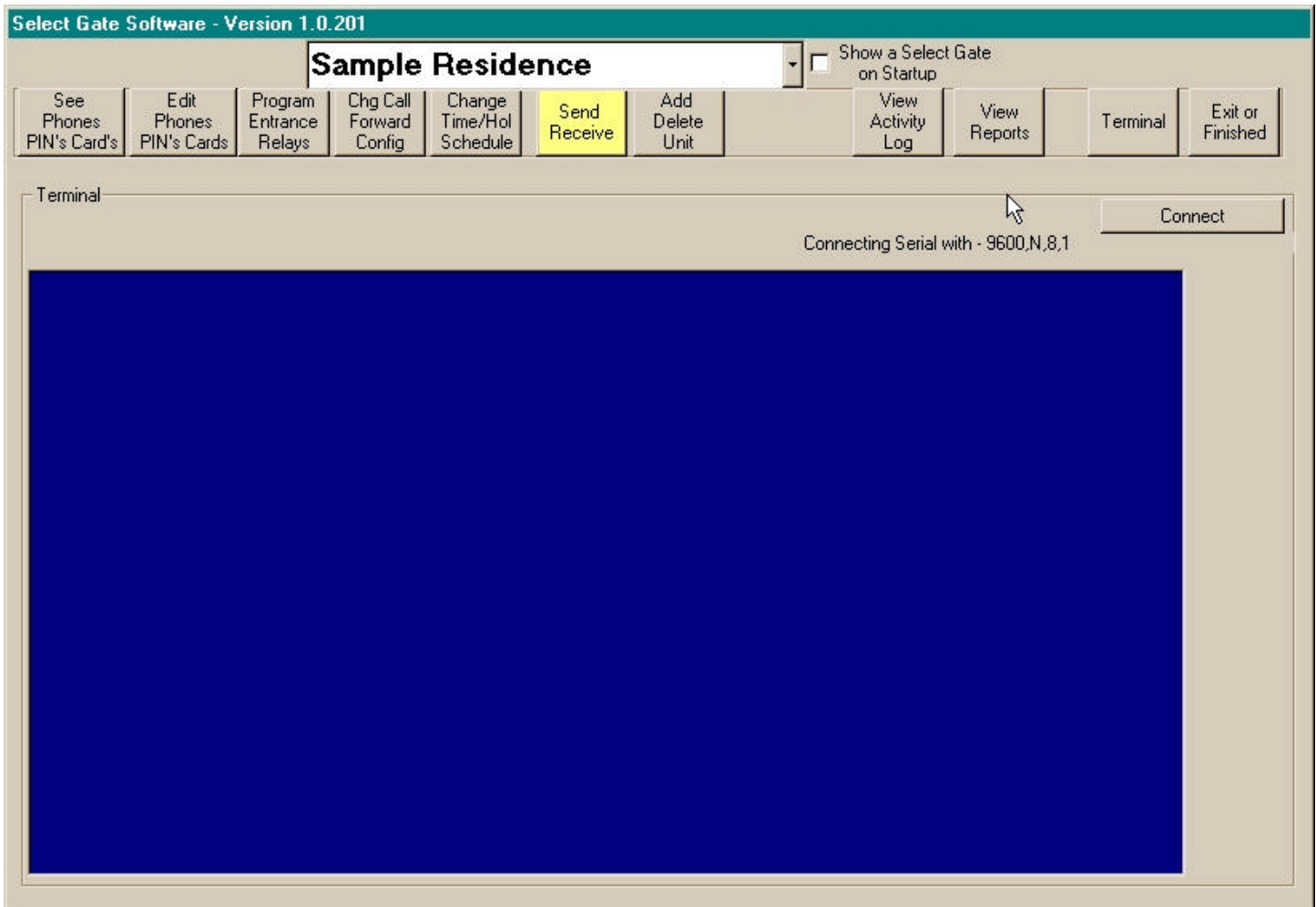

Helpful Hints

Select Gate Software is designed to use the SMALL(Normal Size) font selection in the Control Panel - Display - Settings - Font Size. Choosing Large fonts will cause some wording not to be displayed correctly. A report is available for all data items. This allows you to print your data and settings using your printer.

General

The [TAB] key [forward] and [Shift Tab] key [backwards] also moves from text window to text window. The [Enter] key generally behaves like the [TAB] key as well.

The minimum computer specified will operate correctly when Select Gate Software is the only program running. Larger computers with more memory will operate faster . For proper operation, other programs should be exited first.

Data Files

Data files and the backups are compatible with Microsoft Access Version 7.0 or higher and may be used to generate reports from the data if desired. Do not convert your data or add, subtract or rename any fields with the Access Data Manager as it will cause Select Gate Software to stop working later.

Remote Data Storage

If you wish to archive your data and/or backup data in another location, copy the files in your SG-2 directory. If you did a standard install, the files are in **C:\Program Files\SG2-1*.mdb** .

Version Number

When talking to tech support, your version number (shown on the top of the Window) is very important. Check the version before you call and have it ready .

See Phones Pin's Cards

Selecting this button retrieves a new copy from the disk and resets the records to the name order.

All records are sent to the unit on the next send data .

To print partial Data, use the selector in the report to view pages, then use the page select to view what you want to print, select the proper page and press "Print pages" .

Edit Data

Update record updates the record and resets the program to view Phones PIN's Cards.

Select Gate-2 Single Select Gate & Multiple Select Gate Diagram

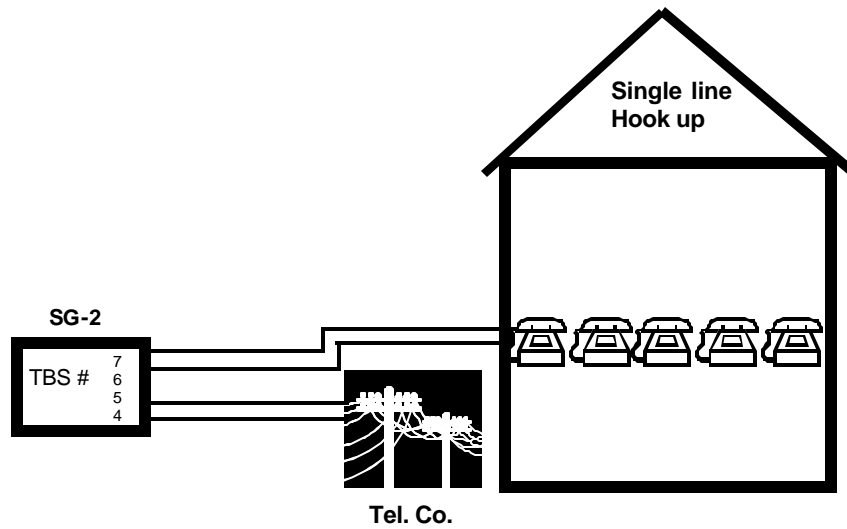

Single Select Gate with Modem on same Phone Line

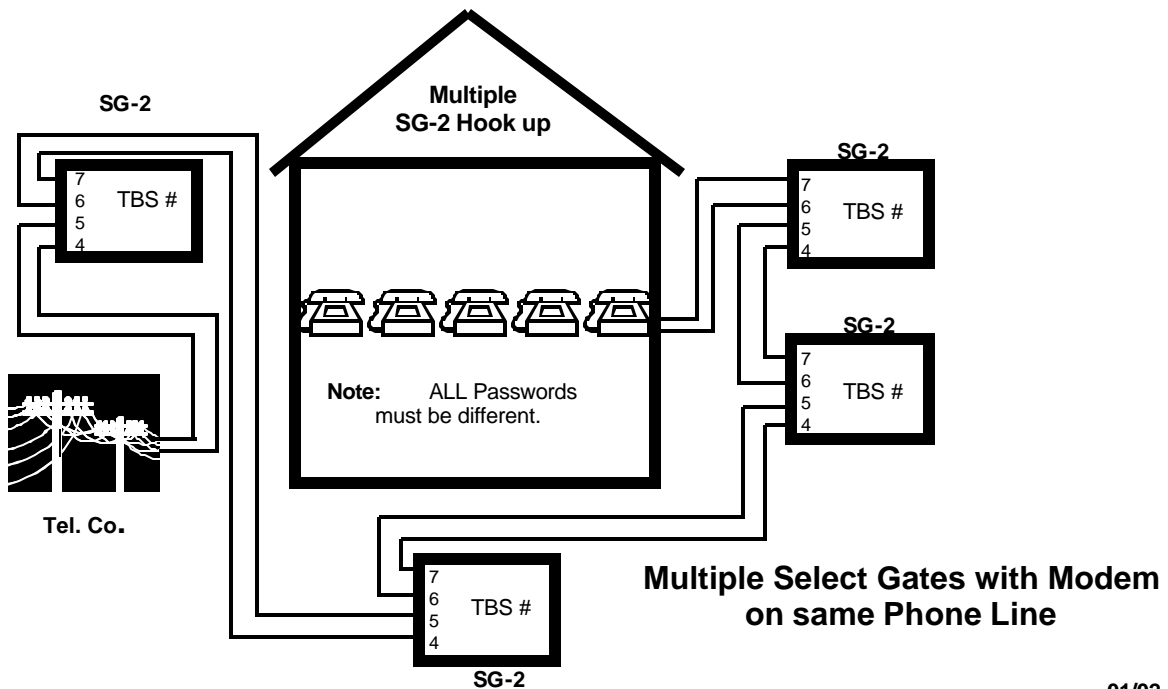

Multiple Select Gates with Modem on same Phone Line

Select Gate-2 Installation Sheet (Basic)

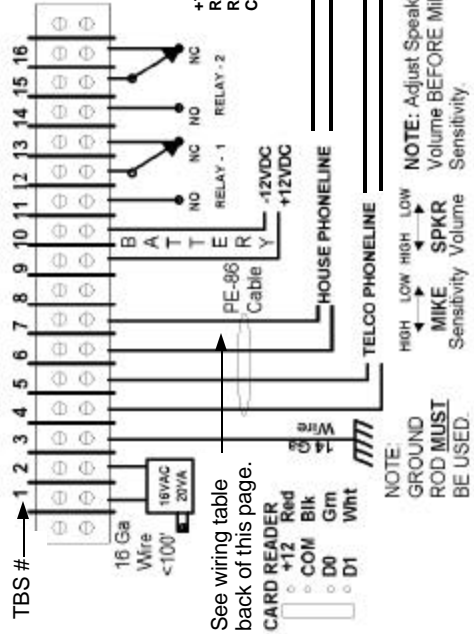

See wiring table back of this page.

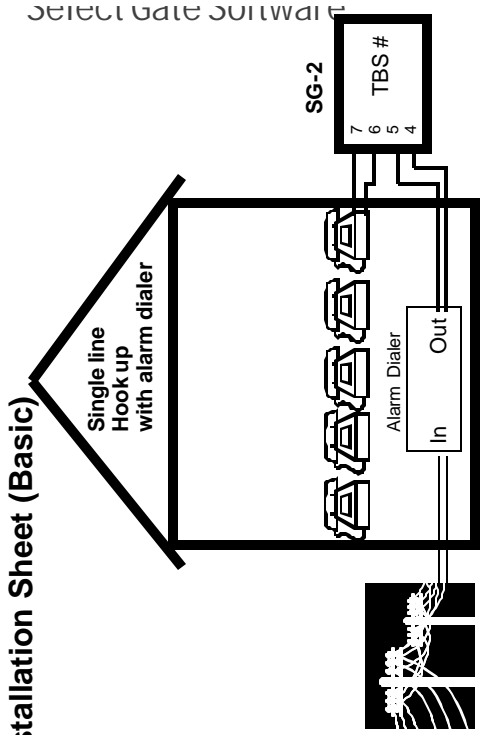
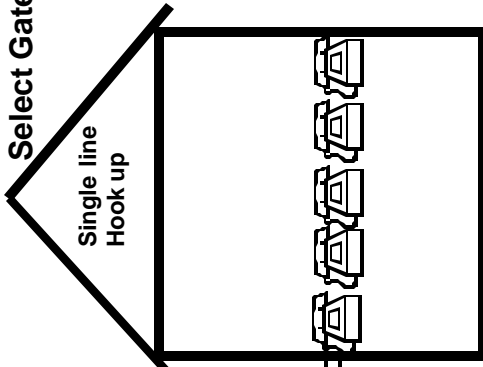

Quick Programming

To get into Program Mode:
Press * and 0 at same time. Hear two beeps.
Press 4 digits of password (7777 factory default).
Hear beep after each key press.
Press *. Hear three beeps.

To Program a Pin code: (Relay 1)
Press 12 00 1234 00 * (Pin Code = 1234 in loc. 00.)
Press 12 01 5678 00 * (Pin Code = 5678 in loc. 01.)

To Delete a Pin Code:
Press 12 00 0000 00 * (Pin Code 1234 deleted.)
Press 12 01 0000 00 * (Pin Code 5678 deleted.)

To Program a Phone Code:
Press 11 0 5551212 * (Phone# 555-1212 in loc. 0.)
Press 11 1 9877654321 * (Phone# 987 765-4321 in loc. 1.)

To Delete a Phone Code:
Press 11 0 0 * (Phone # 555-1212 deleted.)
Press 11 1 0 * (Phone # 987 765-4321 deleted.)

To Program Latch Relay: (Relay 1)
Press 22 7 * (Latch tone = 7.)

To Program Call Forwarding:
Press 61 9 * (Sets call forward tone to 9)
Press 62 0 * (Call forwards without alert to house.)
Press 62 1 * (Call forwards with alert to house.)

To Program Call Forwarding Phone Number:
Press 65 9877654321 * (Call forwards to 987 765-4321.)

To Enable Call Forwarding: (Relay 1)
Press 64 1 *
To Program Gate Open Time: (Relay 1)
Press 24 02 * (Open time = 2 seconds.)
Press 24 13 * (Open time = 13 seconds.)

To Exit Program Mode: Press * and 0 at same time.
Hear three beeps.

Tel. Co.

Tel. Co.

Tel. Co.

Tel. Co.

Tel. Co.

Tel. Co.

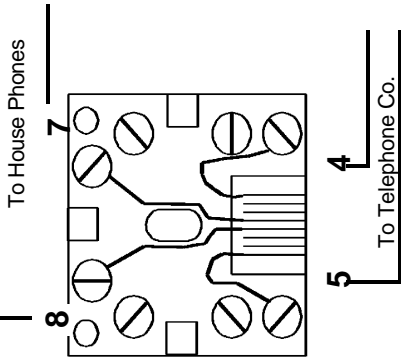

Back-Box Mounting Template

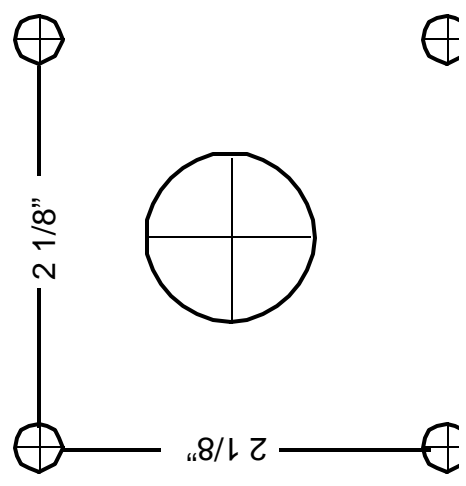

Select Gate-2 Installation Sheet (Advanced)

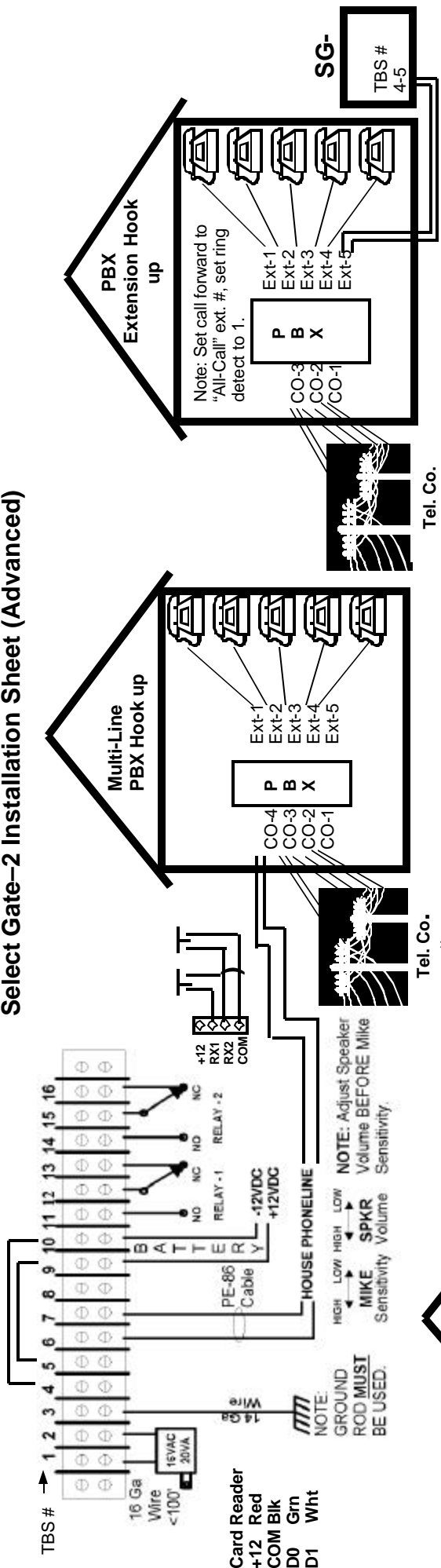

REN (Ringer Equivalence Number) = Number of phones in house that Phone Co. rules say can be rung.
 Total REN value can NOT exceed value of: 5.0
 Look on bottom of instrument, or on equipment label for REN number.
 Typical example:
 2 old style phones @ 1.0 REN = 2.0
 4 new style phones @ .6 REN = 2.4
 1 Computer modem @ .2 REN = .2
 1 Fax machine @ .2 REN = .2
 1 Answering mach. @ .1 REN = .1

Total REN = 4.9

Telephone wiring table.

NOTE: MUST use direct burial rated outside plant wiring in compliance with ANSI/ICEA S-96-634-1996 REA PE-86 or RUS PE-86 requirements.

Wire Mfg	Wire Usage	Wire Type Designation	24 Ga. (Up to 1,000 ft. distance)	22 Ga. (Up to 5,000 ft. distance)	19 Ga. (Up to 10,000 ft. distance)
Superior/Essex	Above Grade	(RUS PE-86) BDW-A	04-098-85	04-055-84	02-023-85
Superior/Essex	Below Grade	(RUS PE-86) BDW-A	04-098-85	04-055-84	02-023-85
Superior/Essex	Gopher/Rodent	(RUS PE-86) BDW-G	04-094-16	04-055-17	04-030-16
General Cable	Below Grade	(RUS PE-86)	2095132	2095126	Not Available
General Cable	Gopher/Rodent	(RUS PE-86)	2095066	2095002	2095102

Card Reader wire/cable table.
 Above grade (recommended installed in pipe). <100 feet: Belden # 9940
 Below grade (Direct burial): <500 feet: Belden # 9883
 Plenum (Fire rated): <500 feet: Belden # 83604
NOTE: Card reader devices that draw > 100 ma. MUST use own external ungrounded DC supply.

Alternate powering table and specifications.
 Idle w/LED lighting: 120 ma.
 Ringing house: 300 ma.
 Combinations of Solar cell chargers of sufficient current output or Batteries, may be wired into TBS-9 (+12 volts) and TBS-10 (-12 volts) to operate SG-2.
NOTE: ANY charging devices (battery charger, etc.) MUST be isolated from earth ground.

01/02

SG-2 Basic programming features

o Begin Programming: Press *80 at same time, 4 digits of pass code then *.
 Factory default = 7777 Key Stroke Example: *0 7777 * and SG-2 will beep after each key stroke and then beep 3 times, if entered password is valid.
Fn = Select Gate 2 Programming Function.

Pins 1-100 (Fn 12)
 12 Code XX PIN XXXX Relay Action X Time Schedule X then *.
 Key Stroke Example: 12 01 1234 0 * will open with *1234 on relay 1 for timed amount, 24 hrs a day.
 Or: 12 02 5678 3 2 * will open relay 1 & 2 for timed amount with key strokes *5678, on hours or days, that Time Schedule 2 is true.
 Or: 12 03 1289 7 0 * will latch relay 1 on with key strokes *1289 and keep it on, until PIN 1234 is keyed in, to unlatch relay 1.
 If start and stop dates are desired, add start month and day and end month and day after time schedule.
 Key Stroke Example: 12 01 1234 0 05 22 07 01 will be valid from May 22 to July 1st. If date not desired, press * after Time Schedule choice.
To remove PIN: 12 Code XX O * Example: 12 01 0 * Removes 1234 from above example.

Cards 1-100 (Fn 13)
 13 Code XX Facility Code XXX Card XXXXX Relay Action X Time Schedule X then *.
 Key Stroke Example: 13 01 0101234500 * means card with facility code 010 on card 12345 will open relay 1 for timed amount, 24 hrs a day.
 Or: 13 67 023 56789 2 1 * means card with facility code 023 on card 56789 will open relay 2 for timed amount, whenever Time Schedule 1 is true.
 If start and stop dates are desired, add start month and day and end month and day after Time Schedule.
 Key Stroke Example: 13 01 01012345 00 05 22 07 01 * means card with facility code 10 and Card# 12345 will be valid from May 22 to July 1st. If date not desired, press * after Time Schedule choice.
To remove Card: 13 Code XX O * Example: 13 01 0 * Removes Card 12345 from above example.

Phones 0-9 (Fn 11)
 11 Code X Phone XXXXXXXXXXXXXXX, then *.
 Key Stroke Example: 11 0 18003425737, then * will call that number when 0# is pushed on Key -pad.
 Or: 11 1 9#13055551212, then * will dial 9, wait 1 second, then dial information, when 1# is pushed on keypad.
 Or: 11 3 18003425737 will dial when 3# is pushed on keypad.
To remove Phone: 11 Number X 0 * Example: 11 1 0 * Removes 555-1212 from above example.

Relay 1 Functions

Fn	Key Strokes	Default	Example:
21	Unlock Tone 1—9, 0 = Disabled	21 6 * 6	21 1 * Unlock tone is now 1
22	Latch Tone 1—9, 0 = Disabled	22 0 * 0	22 4 * Latch tone is now 4
23	1 Hour Unlock Tone 1—9, 0 = Disabled	23 0 * 0	23 7 * 1-Hour tone is now 7
24	Open Time 01 —99 default = 02	24 02 * 02 sec.	24 15* Relay on for 15 seconds
25	Relay 1 Auto open Time Schedule	25 0 * 0	25 3 * Door open, if TS3 true.
26	Strike Out Count 0—9,	26 0 * 3	26 3 * 3 strikes & you're out.
27	Lock Out Time 1—4 minutes	27 0 * 1	27 2 * Locked out for 2 min.

Relay Action Table	Time Schedule Table
0 = Relay 1 open 24/7 (For timed amount.)	0 = 24/7 (Will open at any time.)
1 = Relay 1 for Time Schedule	1 = Value of time schedule 1 See values on other side.
2 = Relay 2 for Time Schedule	2 = Value of time schedule 2 See values on other side.
3 = Relay 1 & 2 for Time Schedule	3 = Value of time schedule 3 See values on work sheet.
4 = Relay 1 on forever (latched open)	4 = Value of time schedule 4 See values on work sheet.
5 = Relay 2 on forever (latched open)	5 = Value of time schedule 5 See values on work sheet.
6 = Relay 1 & 2 on forever (latched open)	6 = Value of time schedule 6 See values on work sheet.
7 = Relay 1 on for 1 hour	7 = Value of time schedule 7 See values on work sheet.
8 = Relay 2 on for 1 hour	8 = Value of time schedule 4 & 5 See values on work sheet.
9 = Relay 1 & 2 on for 1 hour	9 = Value of time schedule 6 & 7 See values on work sheet.

Relay 2 Functions

Fn	Key Strokes	Default
31	Unlock Tone 1—9, 0 = Disabled	31 9 * 9
32	Latch Tone 1—9, 0 = Disabled	32 0 * 0
33	1 Hour Unlock Tone 1—9, 0 = Disabled	33 0 * 0
34	Open Time 01 —99 default = 02 sec.	34 02 * 02
35	Relay 2 Auto open Time Schedule	35 0 * 0
36	Relay 2 Special Function 0-1 (Turns on when house called)	36 1 * 0

SG-2 Advanced programming features

To Begin Programming:
 Press *80 at same time, 4 digits of pass code, then *.
 Factory default = 7777 Ex. *0 7777 * and SG-2 will beep after each key stroke and then 3 times, if password is valid.
 (Only one beep if NOT valid.)
Fn = Select Gate 2 Programming Function

Call Forward

Fn	Key Stroke	Default
61	Call Forward Tone 1—9 (0 disables)	61 0 *
62	Call Forward House Notification (Choices are 0—1) (0 rings house 0 times, 1 rings house 1 time)	62 0 *
63	Call Forward Time Schedule 0—9 (TS 1—9, 0 = 24/7)	63 0 *
64	Call Forward On / Off 0—1 (0 = Off, 1 = On)	64 0 *
65	Call Forward Phone Number (Up to 16 digits)	65+(16 dig) * 0

Relay Action Table

0 = Relay 1 open 24/7 (For timed amount.)	Time Schedule Table
1 = Relay 1 for Time Schedule	1 = Value of time schedule 1 See values on work sheet below.
2 = Relay 2 for Time Schedule	2 = Value of time schedule 2 See values on work sheet below.
3 = Relay 1 & 2 for Time Schedule	3 = Value of time schedule 3 See values on work sheet below.
4 = Relay 1 on for 1 hour	4 = Value of time schedule 4 See values on work sheet below.
5 = Relay 2 on for 1 hour	5 = Value of time schedule 5 See values on work sheet below.
6 = Relay 1 & 2 on for 1 hour	6 = Value of time schedule 6 See values on work sheet below.
7 = Relay 1 on forever (latched open)	7 = Value of time schedule 7 See values on work sheet below.
8 = Relay 2 on forever (latched open)	8 = Value of time schedule 4 & 5 See values on work sheet below.
9 = Relay 1 & 2 on forever (latched open)	9 = Value of time schedule 6 & 7 See values on work sheet below.

Maintenance

Keystrokes

831*	Clear Log.
91 1010 *	Clear all Phone numbers.
92 1010 *	Clear all PIN Numbers.
93 1010 *	Clear all Card Numbers.
94	Set all relays to factory defaults.
95 1010 *	Set System * Password.
96 1010 *	Set Call Forward.
97 1010 *	Clear all Time Schedules.
98 1010 *	Clear all Holidays.
99 1010 *	Clear Everything.

Example: 99 1010 * will clear ALL PINs, Phone numbers, Card numbers and set all other functions back to Factory Defaults.

Call Enable Time Schedule

Allows what hours of day and days of week and holidays that Select Gate 2 is allowed to call the house.

Key Strokes Default
 0 = Enabled all the time.
 43 Call Enable Time Schedule 1—9 43 (TS) * 0
 Case 1: Call Enable = 0 Calls house 24/7
 Case 2: Call Enable = 1 Calls when TS1 is true.
 Case 3: Call Enable = 8 Calls when TS4 or TS5 is true.

Set Clock

Fn	Min.	Hour	Day#	Date	Month	Year
79	MM	HH	DW	DD	MM	YY
Example: To set a time of 2:18 PM on Wednesday the 24th of April 2002, you would key in:						
79	18	14	4	24	04	02
Day# (DW)	Sun. = 1		Wed. = 4	Sat. = 7		
	Mon. = 2		Thu. = 5			
	Tue. = 3		Fri. = 6			

Set It and Forget It (Change as Required)

Ring Cadence: S=Short, L=Long

Fn	Key Strokes	Default
41	Ring Type 1—4	1=SS 2=S 3=LS 4=LL
42	Ring Count 1—9	41 1 * 1
43	Call Waiting Type 1—4	42 9 * 9
44	(1=SS 2=SL 3=LS 4=LL)	44 1 * 1
45	Ring Detect 00—99	45 09 * 09
46	Back Beep 0 = Off, 1 = On	46 0 * 0
47	Talk Time 1—9 Minutes.	47 1 * 1
48	Keypad active after calling house (0 = Off, 1 = On)	48 0 * 0
51	Programming Password	51 7777 * 7777

Set Holidays

Fn	H	MM	DD	Key Strokes
78	0	_____	_____	* 780 MMDD *
78	1	_____	_____	* 781 MMDD *
78	2	_____	_____	* 782 MMDD *
78	3	_____	_____	* 783 MMDD *
78	4	_____	_____	* 784 MMDD *
78	5	_____	_____	* 785 MMDD *
78	6	_____	_____	* 786 MMDD *
78	7	_____	_____	* 787 MMDD *
78	8	_____	_____	* 788 MMDD *
78	9	_____	_____	* 789 MMDD *

Example: (New Year's Day) 780 01 01 *

Set Time Schedule Worksheet

Fn	TS	SH	SM	EH	EM	Su	Mo	Tu	We	Th	Fr	Sa	Su
7	1	_____	_____	_____	_____	_____	_____	_____	_____	_____	_____	_____	_____
7	2	_____	_____	_____	_____	_____	_____	_____	_____	_____	_____	_____	_____
7	3	_____	_____	_____	_____	_____	_____	_____	_____	_____	_____	_____	_____
7	4	_____	_____	_____	_____	_____	_____	_____	_____	_____	_____	_____	_____
7	5	_____	_____	_____	_____	_____	_____	_____	_____	_____	_____	_____	_____
7	6	_____	_____	_____	_____	_____	_____	_____	_____	_____	_____	_____	_____
7	7	_____	_____	_____	_____	_____	_____	_____	_____	_____	_____	_____	_____

Use this worksheet to plan what times of day, or days of week, you want to be valid.

8 Time Schedule 8 is combination of TS-4 & TS-5
 9 Time Schedule 9 is combination of TS-6 & TS-7
 0 Time Schedule Zero is always valid 24/7

Example: Set TS 1 to open from 8:30 AM to 1:15 PM (add 12 to PM numbers) All days and holidays: Keystrokes = 7 1 0830131512345678 * If you make a mistake on any Time Schedule entry, press # and re-enter from beginning.

This page is intentionally blank

Access Number Devices (Cards)	Page 10	Name Item Reference	Page 11
Activity Log	Page 25	Name Select Gate	Page 24
Add Access Control Device (Card)	Page 12	Personal Identification Numbers (PIN)	Page 10
Add Phone	Page 12	Phone Number, Call forward	Page 16
Add PIN	Page 12	Phone Numbers	Page 10
Add Select Gate	Page 24	Printing Reports	Page 26
Answer Count (Ring in Count)	Page 17	Receive & Send Parameters	Page 20
Cards (Access Number Devices)	Page 10	Relay Entrance Names	Page 15
Command (Function) Buttons	Page 08	Relay Entrance Parameters	Page 15
Clock Setting	Page 21	Reports, Printing	Page 26
Configuration	Page 16	Ring House Count (House Ring Count)	Page 17
Default Unit	Page 09	Sample Data	Page 08
Entrance Relay Names	Page 15	Setting Clock	Page 21
Entrance Relay Parameters	Page 15	Send & Receive Parameters	Page 20
Getting Data (Receive) from Select Gate	Page 20	Sending Data to Select Gate	Page 20
Hard Disk Space	Page 06	Setup Manual	Page 27
Hardware Instructions	Page 29	Setup Software	Page 07
Hints for User	Page 28	Short Cuts	Page 28
Holiday Schedule	Page 18	Start Date	Page 11
Install Software	Page 07	Stop Date	Page 11
Instructions, Hardware	Page 29	Terminal	Page 27
Life Policy	Page 02	Time Schedule	Page 18
Loc Numbers (Location)	Page 10	Time Schedule Uses	Page 19
Location Number (Loc)	Page 10	View Access Control Device (Card)	Page 10
Manual Setup	Page 27	View Activity Log	Page 25
Memory Requirements	Page 06	View Phone	Page 10
Modem Setup	Page 21	View PIN	Page 10
MUI (Multiple Unit Interface) Calling	Page 22	Windows 95 Users	Page 03
MUI (Multiple Unit Interface) Configuration	Page 22	Windows NT 4.0 Users	Page 03
Name Entrance Relay	Page 14	Y2K Compliance	Page 02

“BETTER TECHNOLOGY MAKES BETTER SYSTEMS”

05/03



**Select
Engineered
Systems, Inc.
7991 West 26th Ave.
Hialeah, FL 33016
Toll Free: 1-800-342-5737
In FL: 305-823-5410
Fax: 305-823-5215
website www.selectses.com
e-mail sales@selectses.com**